



Complete Freeze Protection for Process Instrumentation

为过程仪表提供全面的防冻保护

Totaal pakket voor de vorstbeveiliging van uw proces instrumentatie

Protection-basse température complète pour l'instrumentation

Kompletter Frostschutz für Prozess-Instrumentierung

Completa protezione antigelo per strumentazione di processo

Komplett frostsikring av prosess instrumenter

Комплексная защита от замерзания приборов и процессных линий кипи

Completa Proteccion Contra Congelacion Para Instrumentacion de Proceso

TRACEPAK®

Design | Enclosures | Supports | Tubing Bundle | Installation



An engineered, preinsulated tubing bundle system

TRACEPAK solves problems for analytical, instrumentation and mechanical plant utility applications:

- ▼ Freezing,
- ▼ Dew point Component drop-out,
- ▼ Viscosity,
- ▼ Personnel protection

Freezing, dew point, component drop-out and viscosity control are major considerations in instrument impulse connections, small diameter process lines and analyzer sample transport. A properly designed and selected pretraced tubing bundle offers an effective solution to these problems.

The economical choice to field fabrication

Maintenance free TRACEPAK not only saves money and time during the installation process, but it ensures consistent, repeatable performance. Field fabrication requires a pipe fitter to lay out, measure, cut, dress, bend and install the tubing. Next the tracer (steam or electric) has to be installed and insulation put on the tubing. Finally, a weatherproof covering needs to be applied over the insulation. Clearly the economics of the TRACEPAK system versus field fabrication are significant.

Provides predictable and repeatable performance

O'Brien, long recognized as the leader in providing reliable instrumentation protection, has simplified installation while offering predictable operation. TRACEPAK tube bundles are prefabricated, pre-engineered and preinsulated assemblies.

Installation is simplified by the unique parallel configuration, in which process and tracer lines are always parallel inside the bundle. The bundle is much easier to bend during field routing and hookup because all tubes bend together and not against one another.

Connections are easy because tubing stays round and is not work hardened

TRACEPAK's configuration allows the tubing to stay round and malleable when used in conjunction with compression and flare fittings. The installation of process and instrument connections requires only a simple, one-plane offset bend to engage tubing and fittings.

Can be installed at temperatures as low as -40°

O'Brien Corporation utilizes the highest quality materials. Our TPU jacket contains no halogens, eliminating the possibility of chlorides from the jacket causing stress corrosion in stainless steel tubing. This jacket has excellent abrasion and chemical resistance along with a wide, usable temperature range. TRACEPAK can be installed in temperatures as low as -40°.

Common types of pretraced lines:

- ▼ Electric traced lines, TPE, for freeze protection and maintenance of temperature.
- ▼ Steam traced lines, TPL & TPH, for freeze protection and temperature maintenance.
- ▼ Single preinsulated line, S-LINE, primarily for steam supply and condensate return.

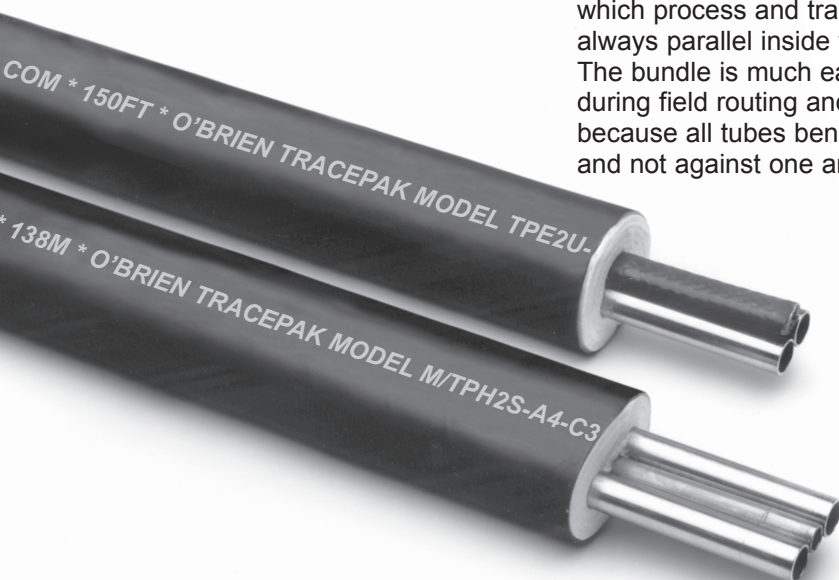

Specifications subject to change without notice.

Systems Approach

Protecting instrumentation and tubing from freezing or maintaining process fluids at elevated temperatures involves many components, designs and engineering skills. Instead of specifying and purchasing individual components, have O'Brien provide an integrated solution with one source responsibility.

DESIGN and SUPPORT for impulse lines and instrument freeze protection combined with field support services sets the O'Brien solution apart from all others.

TRACEPAK® engineered, preinsulated tubing bundle for instrument impulse, sample transport, and small diameter process lines.

VIPAK® engineered enclosure system designed for process instrumentation. **TRAKMOUNT®** and factory installation of instrumentation makes field work easy.



The typical way.



The O'Brien solution.

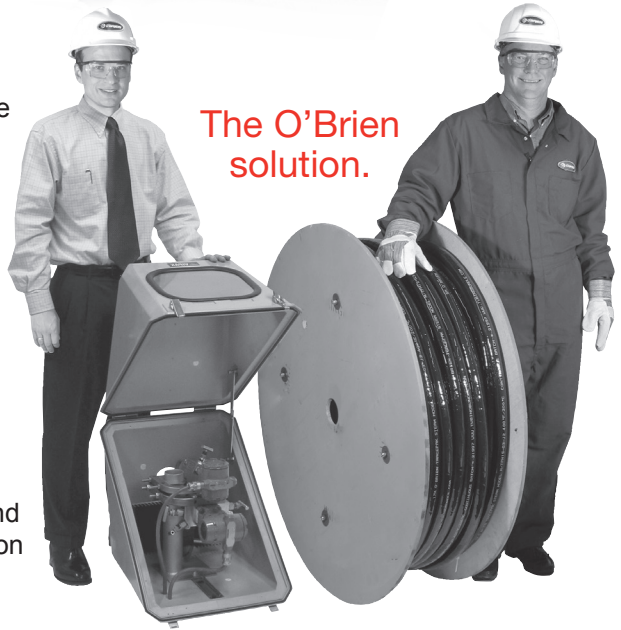

Typical applications for the TRACEPAK system:

INSTRUMENT IMPULSE LINES

- flow transmitters
- pressure transmitters
- level transmitters
- pressure switches
- controllers

ANALYZER SAMPLE LINES

- process analyzers
- chromatographs
- emissions monitoring

MECHANICAL AND PLANT UTILITY PROCESS LINES

- steam supply
- condensate return
- water purge
- chemical feed
- air lines

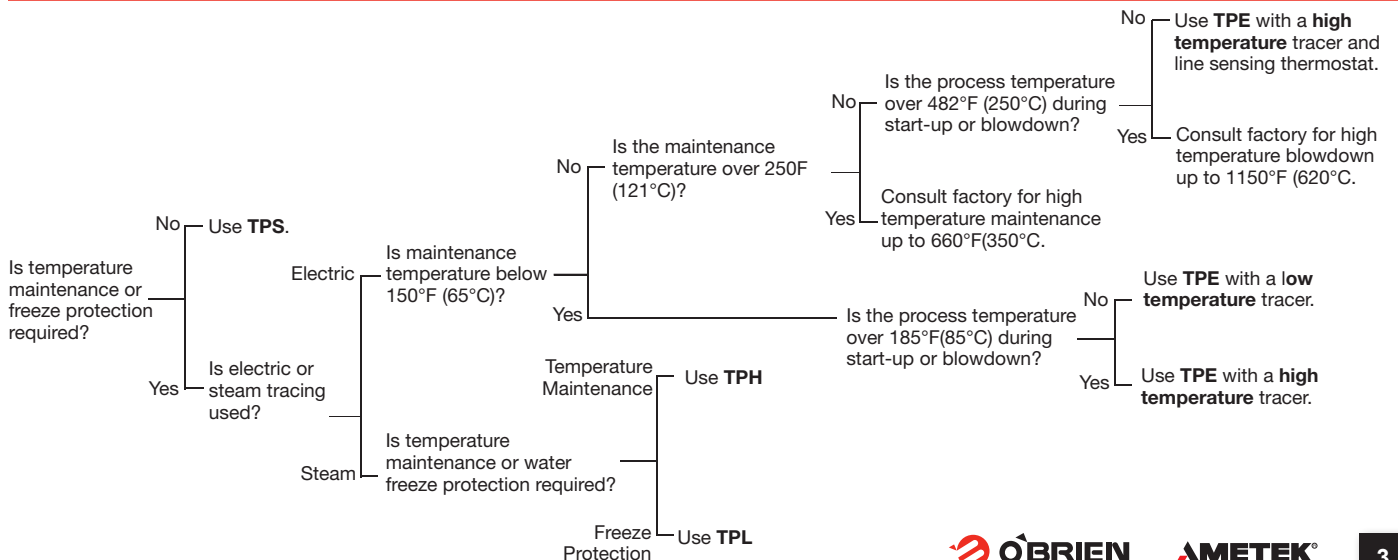

TPE SELF REGULATING

A preinsulated tubing bundle with self regulating electric tracing

TPE is designed to maintain freeze protection, close temperature tolerances or viscosity control.

It provides an excellent means of maintaining very long, continuous lengths of impulse lines and piping at consistent temperatures end-to-end. TPE should be chosen when electric tracing is preferred, steam is not available or when the steam supply could be interrupted such as during shutdowns.

Use TPE if the allowable temperature ranges from 50°F (10°C) to 250°F (121°C). Because it is self regulating, this system will lower its heat output as the process tube gets warmer. When close temperature control is necessary, TPE can be utilized with an optional line sensing thermostat.

Electric tracer

Standard TPE-Self Regulating products utilize two electric tracers approved for use in hazardous areas when installed with the recommended power connection kits.

The high temperature, Self Regulating Tracer:

1. Withstands 482°F (250°C) intermittent blowdown temperatures.
2. Can maintain temperatures up to 250°F (121°C).

The low temperature Self Regulating Tracer:

1. Withstands up to 185°F (85°C) intermittent blowdown temperatures.
2. Can maintain temperatures up to 150°F (65°C).

The choice between high and low temperature tracers must be made based on the desired performance and the conditions of the application.

Other designs are available to maintain temperatures up to 350°F (180°C) and withstand 1150°F (620°C) blowdown conditions. Consult factory for specific design.

Typical Performance

Each graph shows typical performance splitting summer/winter ambients. Each line is separated at 60°F (15°C) to designate the seasonal differences.

Winter ambients, below 60°F (15°C), assume a 25 mph (40 Km/H) wind and summer ambients, above 60°F (15°C), assume a 10 mph (16 Km/H) wind. For freeze protection, use 50°F (10°C) as the minimum allowable process tube temperature. This will provide a sufficient factor of safety.

Dimensions

| | NOMINAL WT. LB/FT (KG/M) | NOMINAL DIMENSIONS - IN (CM) | |
|------------------------------|--------------------------|------------------------------|-----------|
| | | A | B |
| TPE1- One 1/4" Process Tube | 0.3 (0.45) | 1.1 (2.8) | 1.0 (2.5) |
| TPE1- One 3/8" Process Tube | 0.4 (0.60) | 1.3 (3.3) | 1.0 (2.5) |
| TPE1- One 1/2" Process Tube | 0.5 (0.74) | 1.4 (3.6) | 1.1 (2.8) |
| TPE2- Two 1/4" Process Tubes | 0.4 (0.60) | 1.3 (3.3) | 1.1 (2.8) |
| TPE2- Two 3/8" Process Tubes | 0.6 (0.89) | 1.5 (3.8) | 1.2 (3.0) |
| TPE2- Two 1/2" Process Tubes | 0.8 (1.19) | 1.7 (4.3) | 1.4 (3.6) |

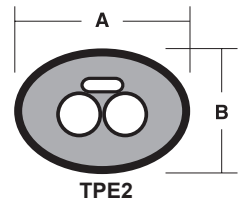
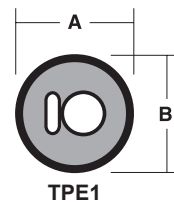

TPE1 - ONE 1/2" (12mm) PROCESS LINE WITH LOW TEMPERATURE TRACER

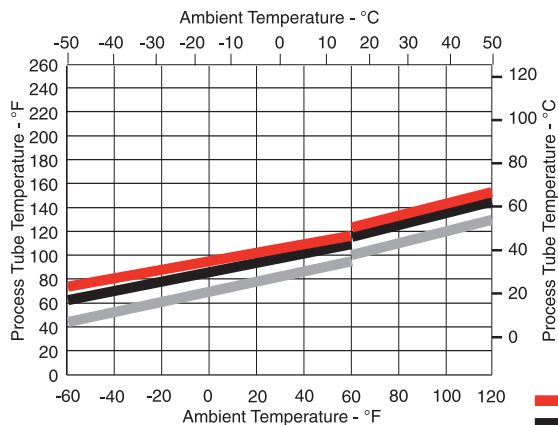

TPE2 - TWO 1/2" (12mm) PROCESS LINES WITH LOW TEMPERATURE TRACER

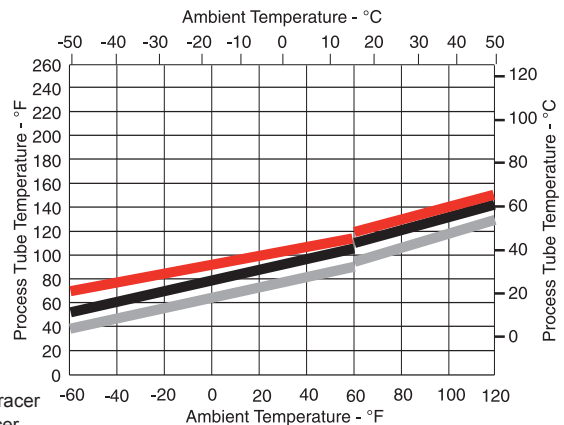

Performance shown at 120V and 240V.



Model Number

Product Family

TPE1- Preinsulated Electrically Traced Single Process Tube

TPE2- Preinsulated Electrically Traced Dual Process Tubes

Jacket

S - SV47 (PVC)

U - TPU (Polyurethane)

Process Tube

- A2** 1/4" x 0.035 wall welded 316SS
- A3** 3/8" x 0.035 wall welded 316SS
- A4** 1/2" x 0.035 wall welded 316SS
- E4** 1/2" x 0.049 wall welded 316SS
- F1** 1/8" x 0.035 wall seamless 316SS
- F2** 1/4" x 0.035 wall seamless 316SS
- F3** 3/8" x 0.035 wall seamless 316SS
- F4** 1/2" x 0.035 wall seamless 316SS
- B2** 1/4" x 0.049 wall seamless 316SS
- B3** 3/8" x 0.049 wall seamless 316SS
- B4** 1/2" x 0.049 wall seamless 316SS
- B6** 3/4" x 0.049 wall seamless 316SS
- G2** 1/4" x 0.030 wall PFA
- G3** 3/8" x 0.030 wall PFA
- H3** 3/8" x 0.062 wall PFA
- H4** 1/2" x 0.062 wall PFA
- K4** 1/2" x 0.065 wall seamless 316SS
- S2** 1/4" x 0.040 wall extruded PFA
- MF6** 6mm x 1mm wall seamless 316SS
- MF8** 8mm x 1mm wall seamless 316SS
- MF10** 10mm x 1mm wall seamless 316SS
- MF12** 12mm x 1mm wall seamless 316SS
- MB10** 10mm x 1.5mm wall seamless 316SS
- MB12** 12mm x 1.5mm wall seamless 316SS
- MG6** 6mm x 1mm wall PFA
- MG8** 8mm x 1mm wall PFA
- MG10** 10mm x 1mm wall PFA
- MG12** 12mm x 1mm wall PFA
- MA12** 12mm x 1mm wall welded 316SS

Tracer

High Temperature Tracer

- B5-** 5w/ft (16w/m) self-regulating heater @ 50°F (10°C), 100 - 130V
- B10-** 10w/ft (29w/m) self-regulating heater @ 50°F (10°C), 100 - 130V
- B15-** 15w/ft (47w/m) self-regulating heater @ 50°F (10°C), 100 - 130V
- B20-** 20w/ft (63w/m) self-regulating heater @ 50°F (10°C), 100 - 130V
- N5-** 5w/ft (16w/m) self-regulating heater @ 50°F (10°C), 200 - 277V
- N10-** 10w/ft (29w/m) self-regulating heater @ 50°F (10°C), 200 - 277V
- N15-** 15w/ft (47w/m) self-regulating heater @ 50°F (10°C), 200 - 277V
- N20-** 20w/ft (63w/m) self-regulating heater @ 50°F (10°C), 200 - 277V

Low Temperature Tracer

- J5-** 5w/ft (16w/m) self-regulating heater @ 50°F (10°C), 100 - 130V
- J8-** 8w/ft (25w/m) self-regulating heater @ 50°F (10°C), 100 - 130V
- J10-** 10w/ft (29w/m) self-regulating heater @ 50°F (10°C), 100 - 130V
- P5-** 5w/ft (16w/m) self-regulating heater @ 50°F (10°C), 200 - 277V
- P8-** 8w/ft (25w/m) self-regulating heater @ 50°F (10°C), 240vac
- P10-** 10w/ft (29w/m) self-regulating heater @ 10°C, 240vac

Specialty Tracers

- JV10-** 10w/ft (29w/m) power-limiting heater @ 50°F (10°C), 100 - 130V
- JV20-** 20w/ft (63w/m) power-limiting heater @ 50°F (10°C), 100 - 130V
- JN10-** 10w/ft (29w/m) power-limiting heater @ 50°F (10°C), 200 - 277V
- JN20-** 20w/ft (63w/m) power-limiting heater @ 50°F (10°C), 200 - 277V

Standard tracers have a tinned copper shield and fluoropolymer outer jacket. They are approved to ATEX, CSA, and NEC standards for use in hazardous areas. Most configurations are rated for T3 or lower maximum temperatures. Consult factory for specific approvals.

Example:

TPE2S-A4-B5

Two 1/2" x 0.035 wall 316SS welded process lines with an SV47 jacket and a 5w/ft (16w/m) tracer.

For specific information regarding each of these products, consult the factory or your local representative.

TPE1 - ONE 1/2" (12mm) PROCESS LINE WITH HIGH TEMPERATURE TRACER

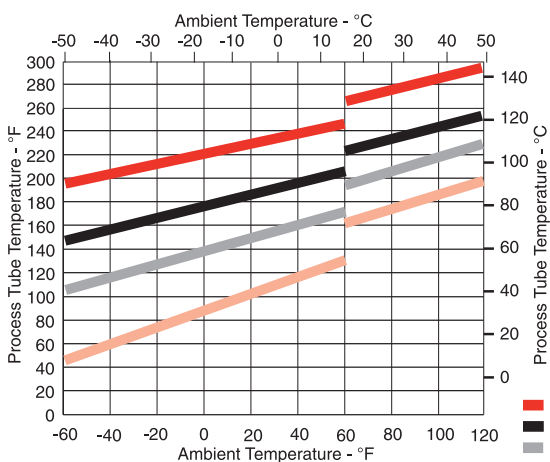

TPE2 - TWO 1/2" (12mm) PROCESS LINES WITH HIGH TEMPERATURE TRACER

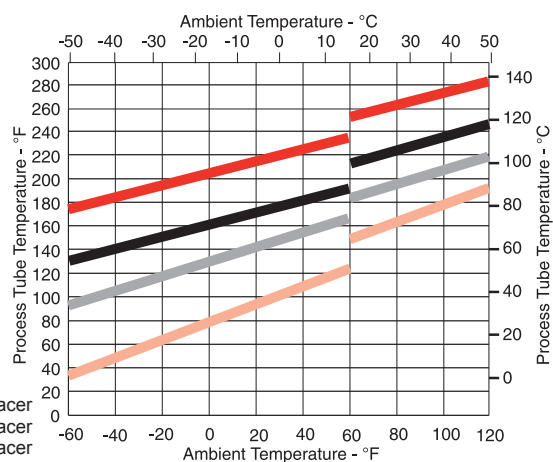

Performance shown at 120V and 240V.

TPL LIGHT STEAM TRACING

A preinsulated tubing bundle with light steam tracing

The tracer tube is wrapped with insulation to purposely reduce heat transfer.

TPL can maintain temperatures between 50°F (10°C) and 200°F (95°C). It provides a more constant tube temperature over a longer length than heavy traced designs.

It is suited for small diameter process lines such as those used for instrumentation, sampling and additives.

TPL is recommended for freeze protection of instrument impulse lines as well as the process lines for analyzers.

Model Number

Product Family

TPL1-Preinsulated Light Steam Traced

Single Process Tube

TPL2-Preinsulated Light Steam Traced

Dual Process Tubes

Jacket

S - SV47 (PVC)

U - TPU (Polyurethane)

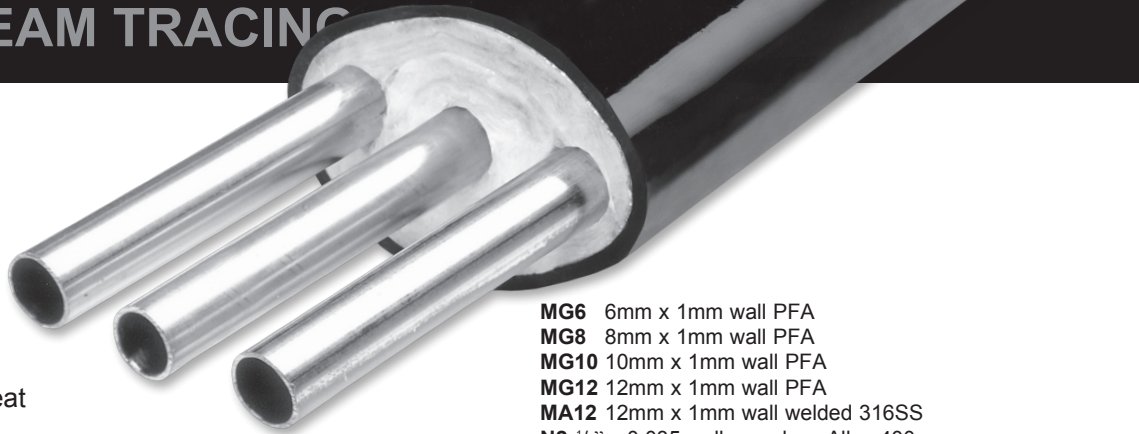

- MG6** 6mm x 1mm wall PFA
- MG8** 8mm x 1mm wall PFA
- MG10** 10mm x 1mm wall PFA
- MG12** 12mm x 1mm wall PFA
- MA12** 12mm x 1mm wall welded 316SS
- N2** 1/4" x 0.035 wall seamless Alloy 400
- N3** 3/8" x 0.035 wall seamless Alloy 400
- P4** 1/2" x 0.049 wall seamless Alloy 400

This is a condensed list of tube and tracer options. For a full product offering consult factory.

Process Tube

- A2** 1/4" x 0.035 wall welded 316SS
- A3** 3/8" x 0.035 wall welded 316SS
- A4** 1/2" x 0.035 wall welded 316SS
- E4** 1/2" x 0.049 wall welded 316SS
- F1** 1/8" x 0.035 wall seamless 316SS
- F2** 1/4" x 0.035 wall seamless 316SS
- F3** 3/8" x 0.035 wall seamless 316SS
- F4** 1/2" x 0.035 wall seamless 316SS
- B2** 1/4" x 0.049 wall seamless 316SS
- B3** 3/8" x 0.049 wall seamless 316SS
- B4** 1/2" x 0.049 wall seamless 316SS
- B6** 3/4" x 0.049 wall seamless 316SS
- K4** 1/2" x 0.065 wall seamless 316SS
- G2** 1/4" x 0.030 wall PFA
- G3** 3/8" x 0.030 wall PFA
- H3** 3/8" x 0.062 wall PFA
- H4** 1/2" x 0.062 wall PFA
- S2** 1/4" x 0.040 wall PFA
- MF6** 6mm x 1mm wall seamless 316SS
- MF8** 8mm x 1mm wall seamless 316SS
- MF10** 10mm x 1mm wall seamless 316SS
- MF12** 12mm x 1mm wall seamless 316SS
- MB10** 10mm x 1.5mm wall seamless 316SS
- MB12** 12mm x 1.5mm wall seamless 316SS

Tracer

- A2** 1/4" x 0.035 wall welded 316SS
- A3** 3/8" x 0.035 wall welded 316SS
- A4** 1/2" x 0.035 wall welded 316SS
- F2** 1/4" x 0.035 wall seamless 316SS
- F3** 3/8" x 0.035 wall seamless 316SS
- B4** 1/2" x 0.049 wall seamless 316SS
- J2** 1/4" x 0.030 wall copper
- C3** 3/8" x 0.032 wall copper
- M4** 1/2" x 0.049 wall copper
- MF6** 6mm x 1mm wall seamless 316SS
- MF8** 8mm x 1mm wall seamless 316SS
- MF10** 10mm x 1mm wall seamless 316SS
- MF12** 12mm x 1mm wall seamless 316SS
- MD6** 6mm x 1mm wall copper
- MD8** 8mm x 1mm wall copper
- MD10** 10mm x 1mm wall copper
- MD12** 12mm x 1mm wall copper

Example:

TPL2S-A4-C3

Two 1/2" x 0.035 wall 316SS welded process lines with an SV47 jacket and 3/8" x 0.032 wall copper tracer.

For specific information regarding each of these products, consult the factory or your local representative.

Dimensions

| | NOMINAL WT. LB/FT (KG/M) | NOMINAL DIMENSIONS - IN (CM) | |
|---|--------------------------|------------------------------|-----------|
| | | A | B |
| TPL1 - One 3/8" Process with 3/8" Tracer | 0.63 (0.94) | 2.0 (5.1) | 1.6 (4.1) |
| TPL1 - One 1/2" Process with 3/8" Tracer | 0.81 (1.21) | 2.2 (5.6) | 1.7 (4.3) |
| TPL1 - One 1/2" Process with 1/2" Tracer | 0.85 (1.26) | 2.2 (5.6) | 1.7 (4.3) |
| TPL2 - Two 3/8" Process with 3/8" Tracer | 0.87 (1.26) | 2.3 (5.8) | 1.6 (4.1) |
| TPL2 - Two 1/2" Process with 3/8" Tracer | 1.09 (1.62) | 2.7 (6.9) | 1.7 (4.3) |
| TPL2 - Two 1/2" Process with 1/2" Tracer | 1.13 (1.68) | 2.7 (6.9) | 1.7 (4.3) |

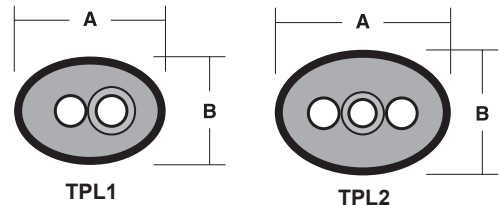

TWO 1/2" (12mm) PROCESS LINES WITH ONE 1/2" (12mm) TRACER TYPICAL PERFORMANCE

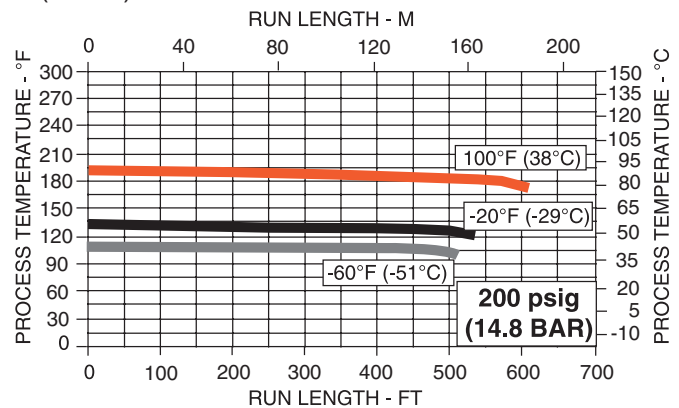
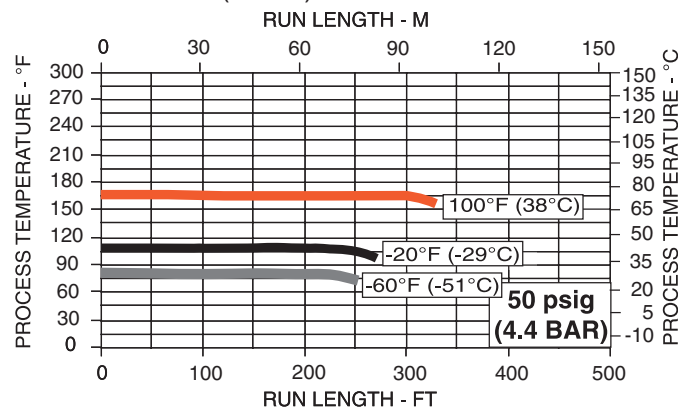

TPH HEAVY STEAM TRACING

A preinsulated tubing bundle with heavy steam tracing



Heavy tracing keeps the process tubing in direct contact with the tracer and maintains higher process temperatures.

TPH is recommended for use on analyzer sample transport and instrumentation impulse lines. It is also recommended for additives and other small diameter process lines where higher temperature maintenance or viscosity control is necessary.

Model Number

Product Family

TPH1-Preinsulated Heavy Steam Traced Single Process Tube

TPH2-Preinsulated Heavy Steam Traced Dual Process Tubes

Jacket

S - SV47 (PVC)

U - TPU (Polyurethane)

This is a condensed list of tube and tracer options. For a full product offering consult factory.

Process Tube

- A2** 1/4" x 0.035 wall welded 316SS
- A3** 3/8" x 0.035 wall welded 316SS
- A4** 1/2" x 0.035 wall welded 316SS
- E4** 1/2" x 0.049 wall welded 316SS
- F1** 1/8" x 0.035 wall seamless 316SS
- F2** 1/4" x 0.035 wall seamless 316SS
- F3** 3/8" x 0.035 wall seamless 316SS
- F4** 1/2" x 0.035 wall seamless 316SS
- B2** 1/4" x 0.049 wall seamless 316SS
- B3** 3/8" x 0.049 wall seamless 316SS
- B4** 1/2" x 0.049 wall seamless 316SS
- B6** 3/4" x 0.049 wall seamless 316SS
- K4** 1/2" x 0.065 wall seamless 316SS
- G2** 1/4" x 0.030 wall PFA
- G3** 3/8" x 0.030 wall PFA
- H3** 3/8" x 0.062 wall PFA
- H4** 1/2" x 0.062 wall PFA
- S2** 1/4" x 0.040 wall PFA
- MF6** 6mm x 1mm wall seamless 316SS
- MF8** 8mm x 1mm wall seamless 316SS
- MF10** 10mm x 1mm wall seamless 316SS
- MF12** 12mm x 1mm wall seamless 316SS
- MB10** 10mm x 1.5mm wall seamless 316SS
- MB12** 12mm x 1.5mm wall seamless 316SS

- MG6** 6mm x 1mm wall PFA
- MG8** 8mm x 1mm wall PFA
- MG10** 10mm x 1mm wall PFA
- MG12** 12mm x 1mm wall PFA
- MA12** 12mm x 1mm wall welded 316SS
- N2** 1/4" x 0.035 wall seamless Alloy 400
- N3** 3/8" x 0.035 wall seamless Alloy 400
- P4** 1/2" x 0.049 wall seamless Alloy 400

Tracer

- A2** 1/4" x 0.035 wall welded 316SS
- A3** 3/8" x 0.035 wall welded 316SS
- A4** 1/2" x 0.035 wall welded 316SS
- F2** 1/4" x 0.035 wall seamless 316SS
- F3** 3/8" x 0.035 wall seamless 316SS
- B4** 1/2" x 0.049 wall seamless 316SS
- J2** 1/4" x 0.030 wall copper
- C3** 3/8" x 0.032 wall copper
- M4** 1/2" x 0.049 wall copper
- MF6** 6mm x 1mm wall seamless 316SS
- MF8** 8mm x 1mm wall seamless 316SS
- MF10** 10mm x 1mm wall seamless 316SS
- MF12** 12mm x 1mm wall seamless 316SS
- MD6** 6mm x 1mm wall copper
- MD8** 8mm x 1mm wall copper
- MD10** 10mm x 1mm wall copper
- MD12** 12mm x 1mm wall copper

Example:

TPH2S-A4-C3

Two 1/2" x 0.035 wall 316SS welded process lines with an SV47 jacket and 3/8" x 0.032 wall copper tracer.

For specific information regarding each of these products, consult the factory or your local representative.

Dimensions

| | NOMINAL WT. LB/FT (KG/M) | NOMINAL DIMENSIONS - IN (CM) | |
|--|-----------------------------|------------------------------|-----------|
| | | A | B |
| TPH1- One 3/8" Process with 3/8" Tracer | 0.5 (0.74) | 1.5 (3.8) | 1.2 (3.0) |
| TPH1- One 1/2" Process with 3/8" Tracer | 0.6 (0.89) | 1.6 (4.1) | 1.2 (3.0) |
| TPH1- One 1/2" Process with 1/2" Tracer | 0.7 (1.04) | 1.7 (4.3) | 1.2 (3.0) |
| TPH2- Two 3/8" Process with 3/8" Tracer | 0.6 (0.89) | 2.0 (5.1) | 1.2 (3.0) |
| TPH2- Two 1/2" Process with 3/8" Tracer | 0.7 (1.04) | 2.1 (5.4) | 1.2 (3.0) |
| TPH2- Two 1/2" Process with 1/2" Tracer | 0.8 (1.19) | 2.2 (5.6) | 1.2 (3.0) |

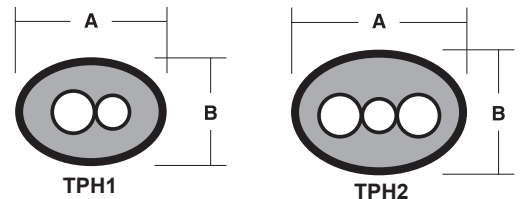

TWO 1/2" (12mm) PROCESS LINES WITH ONE 3/8" (10mm) TRACER TYPICAL PERFORMANCE

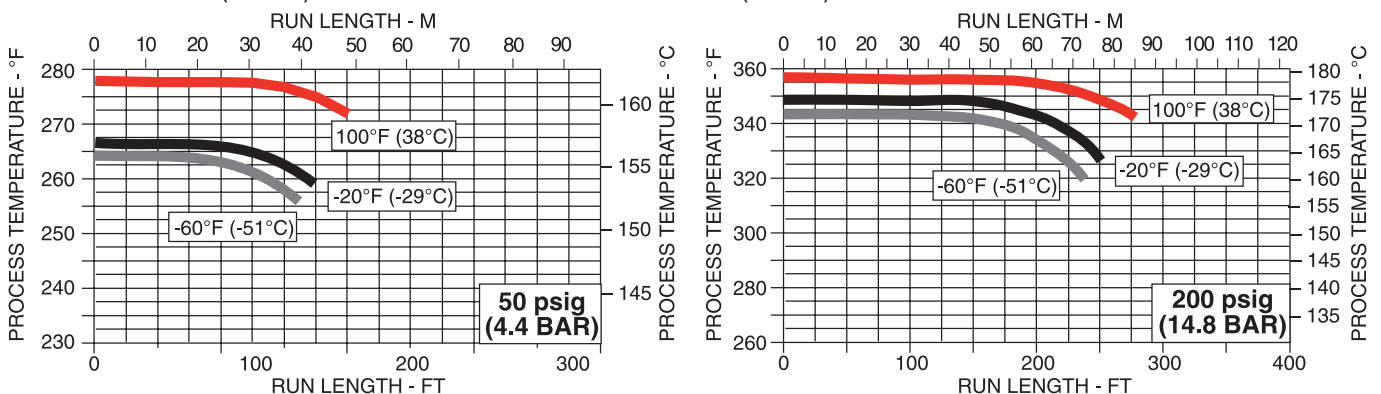

S-LINE® & J-LINE®

S-LINE:

A weather-proofed, preinsulated single tubing line

S-LINE is suggested for 1" (25mm) and smaller steam, condensate, liquid and gas transport lines where personnel protection and heat loss are important. S-LINE offers an inexpensive alternative to field insulation and weatherproofing of small diameter lines.

J-LINE:

A weather-proofed, single tubing line

J-Line tubing is designed for pneumatic and hydraulic applications in corrosive atmospheres. Industry standard tubing coated with O'Brien SV47 (PVC) polymer provides increased protection against galvanic and atmospheric corrosion as well as cushioning the tube against wear from vibration.



Model Number

Product Family

S-Preinsulated Single Process Tube with an SV47 Jacket

J-Single Process Tube with an SV47 Jacket

Process Tube

- A2 1/4" x 0.035 wall welded 316SS
- A3 3/8" x 0.035 wall welded 316SS
- A4 1/2" x 0.035 wall welded 316SS
- E4 1/2" x 0.049 wall welded 316SS
- F1 1/8" x 0.035 wall seamless 316SS
- F2 1/4" x 0.035 wall seamless 316SS
- F3 3/8" x 0.035 wall seamless 316SS
- F4 1/2" x 0.035 wall seamless 316SS
- B2 1/4" x 0.049 wall seamless 316SS
- B3 3/8" x 0.049 wall seamless 316SS
- B4 1/2" x 0.049 wall seamless 316SS
- B6 3/4" x 0.049 wall seamless 316SS
- J2 1/4" x 0.030 wall copper
- C3 3/8" x 0.032 wall copper
- D4 1/2" x 0.035 wall copper
- M4 1/2" x 0.049 wall copper
- M6 3/4" x 0.049 wall copper
- MF6 6mm x 1mm wall seamless 316SS
- MF8 8mm x 1mm wall seamless 316SS
- MF10 10mm x 1mm wall seamless 316SS
- MF12 12mm x 1mm wall seamless 316SS
- MB10 10mm x 1.5mm wall seamless 316SS
- MB12 12mm x 1.5mm wall seamless 316SS

Examples:

SC3

One preinsulated 3/8" x 0.032 wall copper process line with an SV47 jacket.

JC3

One 3/8" x 0.032 wall copper process line with an SV47 jacket.

For specific information regarding each of these products, consult the factory or your local representative.

Dimensions

| | NOMINAL WT. LB/FT (KG/M) | NOMINAL DIMENSIONS A - IN (CM) |
|-------------------------------|-----------------------------|-----------------------------------|
| S-LINE- One 1/4" Process Line | 0.2 (0.30) | 1.0 (2.5) |
| S-LINE- One 3/8" Process Line | 0.3 (0.45) | 1.1 (2.8) |
| S-LINE- One 1/2" Process Line | 0.4 (0.60) | 1.2 (3.0) |



S-LINE

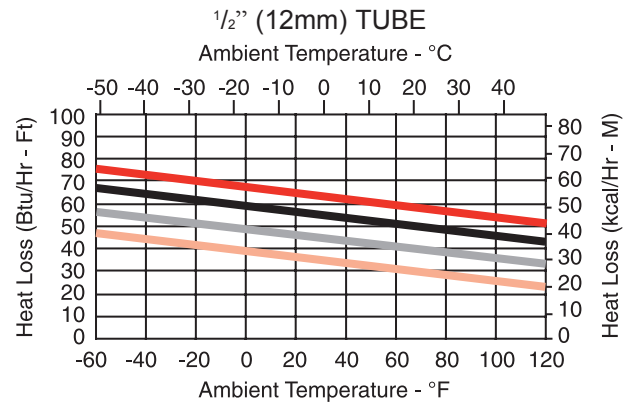
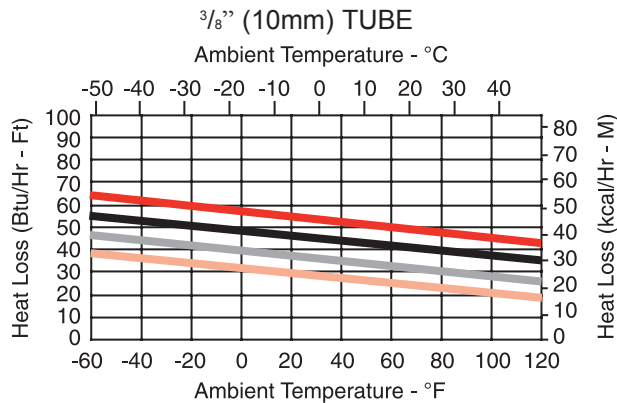

- 200 psig (15 BAR) steam
- 125 psig (9.5 BAR) steam 353°F
- 50 psig (4.5 BAR) steam 299°F
- 15 psig (2.0 BAR) steam 250°F

STACKPAK, TRACEPAK MJ & CUSTOM DESIGNS

Solutions for unique applications

In addition to conventional TRACEPAK designs, O'Brien can satisfy your special needs with custom solutions. Modeling for these designs is verified in our environmental chamber under conditions insuring a tubing bundle that meets your exact requirements, with reliability and accuracy you can depend on.

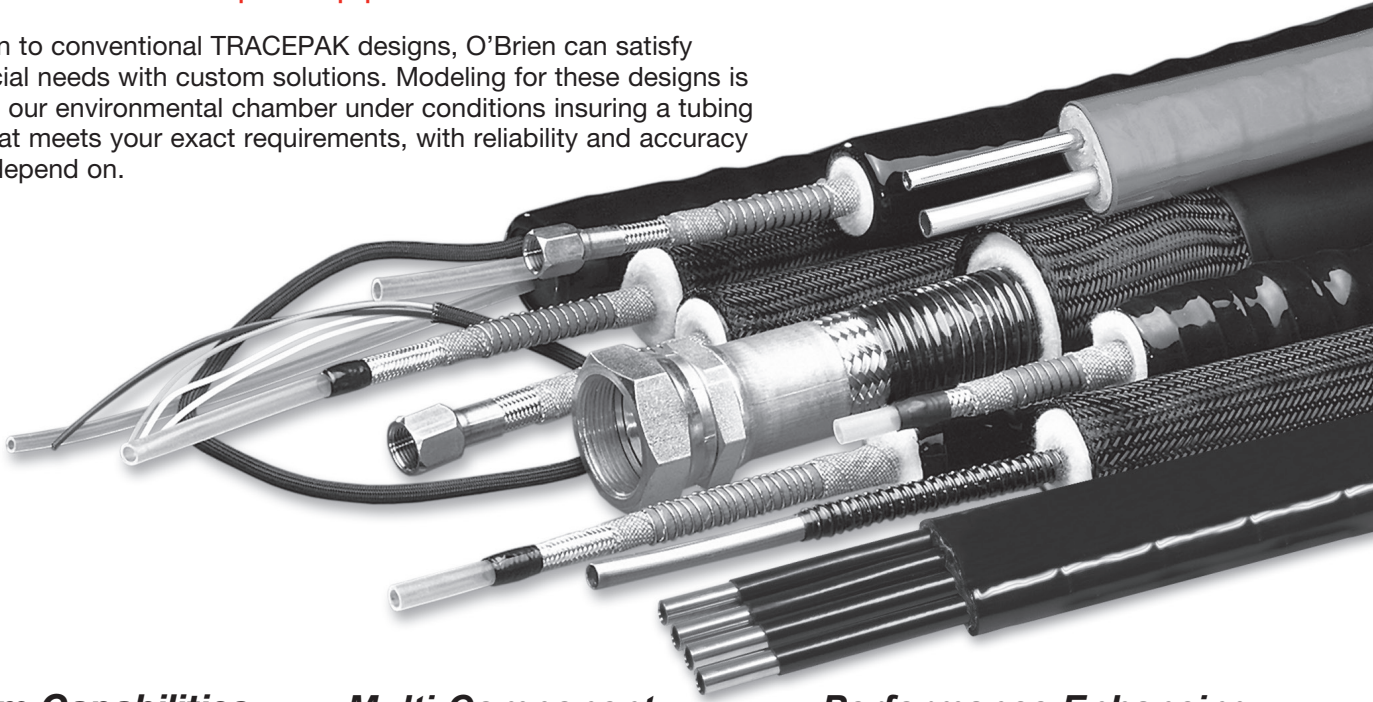

Custom Capabilities

- Indoor & Outdoor Jackets
- Maintenance Temperatures to 660°F (350°C)
- Custom Lengths
- Choice of Process Connection Fittings
- Pre-terminated and Fitted Ends
- Factory Installed Temperature Sensors
- Communication, Monitor and Power Wires
- Alternate Jacket Colors

Unusual Tube Material Nonstandard Sizes

TRACEPAK can be manufactured with a wide range of uncommon materials and sizes to conform to your unique material requirements, including:

- Fluoropolymer variations such as PTFE, PFA, TFE, and nylon.
- Hastelloy
- Incoloy
- Titanium
- Duplex and Super Duplex
- 6% Moly
- Oxygen Cleaned Tubes
- Chemically Polished Stainless Steel with SilcoNert 2000
- Electropolished Stainless Steel with SilcoNert 2000

Multi-Component Bundles

Complex designs incorporate factory installed temperature sensors such as RTD's, PT100's thermocouples with multiple process tubes, calibration gas supply tubes, tracers, communication wires, power wiring, and heat tracing.

High Temperature Heaters

Specialty tracers such as CPD, MI and resistance wires can be used to provide temperature maintenance up to 660°F (350°C) and to withstand a high temperature blowdown of 1150°F (620°C).

Jacket Materials for Diverse Applications

Jacket materials are available to withstand high operating temperatures, permit installation at low ambients or stand up to constant flexing. Materials include polyurethane, polyethylene or PVC for outdoor applications, and polyethylene braid or stainless steel braid for indoor applications.

Performance Enhancing Designs

Special insulated or buffered designs are available for applications with high intermittent process temperatures. These designs insulate the standard self-limiting tracer from the process tube to allow higher maximum exposure temperatures while still providing freeze protection.

Typical Applications

Sampling Systems

Emissions Gas Sampling,
Process and Portable Analyzers
Automotive Emissions Testing

Viscosity Control

Petroleum products, Asphalt, Tar,
Paint Systems, Printing Ink, Coatings,
Spray Foam Insulation

Product Transfer

Polymers, Oils, Urethanes, Waxes,
Chemicals, Food Products, Hot Melt
Adhesives, Sanitary and High Purity
Applications

Corrosion Protection

Jacketed tubing for harsh
environments such as Marine
and Offshore.

®Silcosteel and Sulfinert are registered trademarks of Restek Corporation.

ACCESSORIES Sealing the Bundle

Although TRACEPAK products use a non-hygroscopic, non-wicking insulation, all bundle ends must be sealed to prevent any possible moisture contamination.

TPKSK-10 - Silicone Sealant

This option is used to seal both ends of the tubing bundle from moisture. It is a black silicone RTV sealant. Cure time is approximately 24 hours at 77°F (25°C). Service temperature ranges from -50°F (-45°C) to 400°F (205°C). TPKSK offers excellent resistance to weather, oil and many chemicals.

To Order: **TPKSK-10** End Seal Kit, RTV Sealant, 10 oz. will seal approximately 10 ends



TPKJP-SR-B - Self Bonding Silicone Tape

This option is used to seal both ends of the tubing bundle from moisture. It is a black silicone, self bonding.

To Order: **TPKJP-SR-B** Self Bonding Tape, 36 yd (33m)

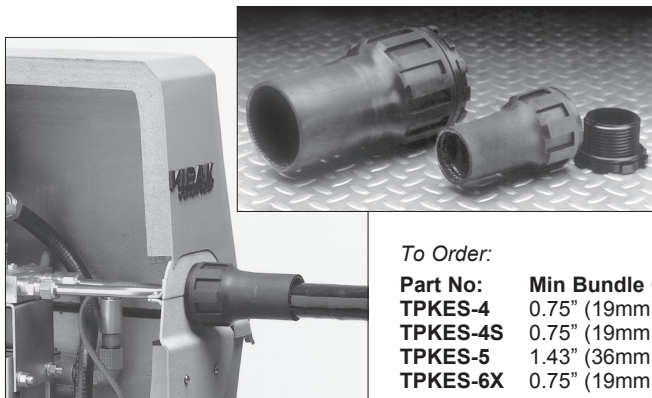

TPKES - Heat Shrink Entry Seal

The heat-shrinkable entry seal provides a waterproof fitting where TRACEPAK enters an enclosure. They can be added to parting line or surface mounted plates on VIPAK enclosures. The thermally stabilized, modified polyolefin entry seal consists of a threaded assembly that seals at the enclosure and a heat-shrinkable nose that seals to the TRACEPAK bundle.

To Order:

| Part No: | Min Bundle OD | Max Bundle OD | Max Panel Thickness |
|-----------------|---------------|---------------|---------------------|
| TPKES-4 | 0.75" (19mm) | 1.60" (40mm) | 0.50" (12mm) |
| TPKES-4S | 0.75" (19mm) | 2.10" (53mm) | 0.50" (12mm) |
| TPKES-5 | 1.43" (36mm) | 2.90" (74mm) | 0.75" (19mm) |
| TPKES-6X | 0.75" (19mm) | 3.50" (90mm) | 0.75" (19mm) |

TPKHS - Heat Shrink Boots

The heat-shrinkable boots provide a weatherproof end seal for TRACEPAK tubing bundles. They are made of thermally stabilized, modified polyolefin. Using a heat shrink end seal boot is recommended for all exposed ends. This installation will provide the best weather seal protection.

To Order:

- TPKHS-A3** TPL2, TPH2 with process tubes greater than 3/8" and 1/4" tracers.
TPE2 with tubes greater than 3/8"
- TPKHS-B3** TPE2, TPL2, or TPH2 all with process tubes 3/8" or smaller
- TPKHS-H3** TPL2 wi E1 with 3/8" or larger tubes. TPL1 with 1/4" tracers
- TPKHS-L2** TPL1 with tracers larger than 1/4"
- TPKHS-D2** TPE1 with 1/4" tube
- TPKHS-E1** S-LINE and TPS1

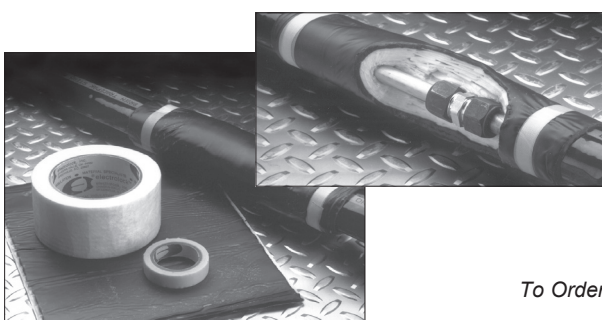
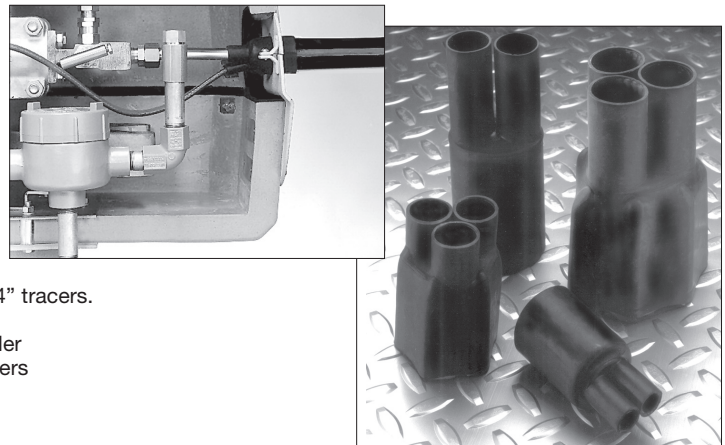

TPKJP - Jacket Patch

The jacket patch kits are used to seal a splice in a bundle or to extend the insulation and weatherproof jacket should the bundle be cut back too far during installation. They are used as a repair patch for any incidental field damage to bundles. The jacket patch kit is required with the optional line temperature sensing thermostat. Each kit contains thermal insulation, fiberglass tape and a self-sealing patch.

To Order:

| | Bundles up to 400°F (204°C) | Bundles up to 1150°F(590°C) |
|----------------|--------------------------------|--------------------------------|
| Small 8" x 12" | TPKJP-1 | TPKJP-3 |
| Large 8" x 96" | TPKJP-2 | TPKJP-4 |

ACCESSORIES Temperature Control

SensorTube™

G2S - 1/4" x 0.030 PFA

H3S - 3/8" x 0.062 PFA

SensorTube creates a pathway for the RTD kit to be positioned up to 15' (4.5m) from the control end without any special tools. This eliminates cutting into the bundle with field installed RTDs. The specially sized bulb and lead construction of the kit can be easily inserted into the bundle even after it is installed. The RTD kit has been inserted through more than five ninety degree bends without problems.

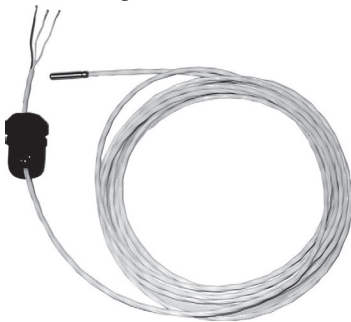

RTD Kit

RTDKIT20 - NEC/CEC standards with 20' fluoropolymer jacketed leads.

RTDKIT20-EX - ATEX  II 2 G Ex e IIC T6..T1 Gb and IECEx Ex IIIC T6..T1 Gb standards with 7 meter Kapton jacketed leads.

RTD Kits include a 100 Ohm PT100, 3 wire sensor and an entry seal. Use single RTD with G2S and dual RTDs with H3S SensorTube.

Consult factory for bundle designs with SensorTube.

1017 Series Controllers

The 1017 Series controllers are compact, full featured, microprocessor based single and dual point heat trace controllers. They provide control and monitoring of Tracepak and Stackpak tubing bundles designed for freeze protection and temperature maintenance. The controllers can be set to monitor and alarm high and low temperature, high and low current, ground fault trip and voltage. The controllers are supplied with a solid-state relay (SSR) for use in nonhazardous and Class I Div. 2 / Zone 2 hazardous areas.

For ordering information consult bulletin QLT-1017



Thermostats

When used with electrically traced tubing bundles, optional thermostats are used to control the temperature of the process tube or to turn on the heater circuit at a specified ambient temperature.



Note:
Models shown are typical of thermostats supplied.
Units received may differ depending on approvals.

Ambient Sensing

The ambient sensing thermostat has an adjustable set point of 15°F to 140°F (-9°C to 60°C) and can withstand ambient temperatures of -40°F to 160°F (-40°C to 71°C). It has a fluid filled stainless steel probe and the SPDT switch is rated for 22A at 125/250/480 VAC. It is UL listed and CSA certified for use in hazardous areas.

To Order: **TPKTS-A-7** Ambient Sensing Thermostat, NEMA 7 Housing, 22 amp 125/250 VAC

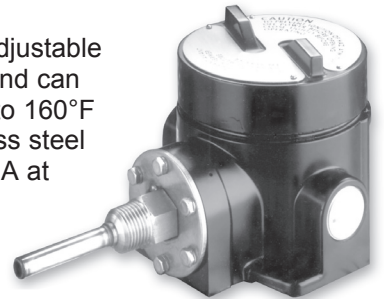

Line Sensing or Ambient Sensing

The line sensing thermostat controls the temperature of the process tubes. It has an adjustable set point of 25°F to 325°F (-4°C to 163°C) and can withstand process temperatures from -40°F to 420°F (-40°C to 215°C). The fluid filled stainless steel bulb has a 10' capillary. The SPDT switch is rated for 22A at 125/250/480 VAC. Model TPKTS-B-7 is UL and FM listed and CSA certified for use in hazardous areas. Model RAYSTAT-EX-02 is EEx d approved for use in hazardous areas.

To Order: **TPKTS-B-7** Line Sensing Thermostat, NEMA 7 Housing, 22 amp 125/250 VAC

ACCESSORIES Power & Termination Kits

Power Connection Kits

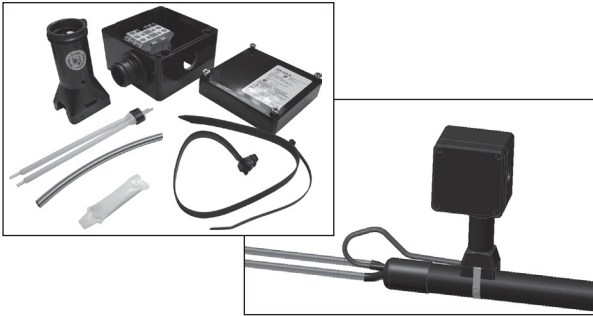

T210-PC

FM Approved and CSA Certified Class I Div. 2 power connection kit for use with any wattage B, N, J, P, JV or JN tracer. Includes junction box and bundle mounting bracket with adjustable straps. Junction box also includes surface mounting feet.

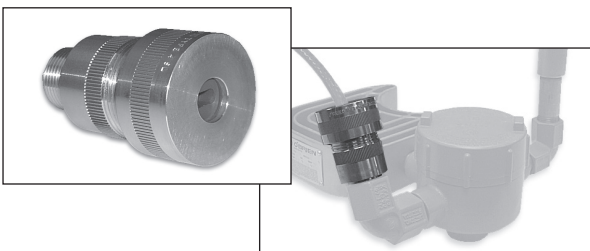

TPC1

CSA Certified Class I Div. 1 power connection or end termination kit for use with any wattage B, N, J or P tracer. Installs in customer supplied junction box with 3/4" npt hub.



T9355-PC

ATEX standards approved power connection kit for use with any wattage B, N, J, P, JV or JN tracer. For use with customer supplied junction box.

End Termination Kits

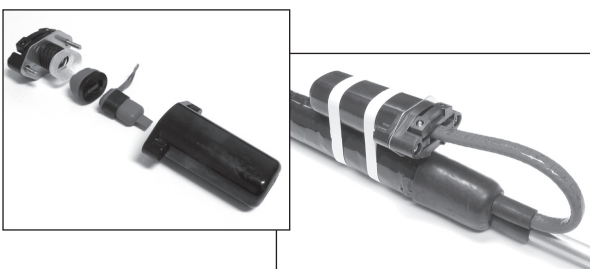

T210-ET

FM Approved and CSA Certified Class I Div. 2, and ATEX EEx ell listed electric tracer termination kit for use with any wattage B, N, J or P tracer.



T355-ET

ATEX standards approved electric tracer termination kit for use with any wattage B, N, J, P, JV or JN tracer.

ACCESSORIES Installation Tools

TRACEPAK is designed to be installed using standard bending tools. We offer two specialized tools that make installation of TRACEPAK tube bundles easier and more compact.

Bundle Bending Tool

Similar to a common electrical conduit bender, this tool is compact and easy to use. It eliminates the need for larger and heavier benders that have 8" (200mm) and 12" (300mm) minimum bending radius.

To Order:

BB8 Bundle Bending Tool with 8" (200mm) Radius
BB12 Bundle Bending Tool with 12" (300mm) Radius

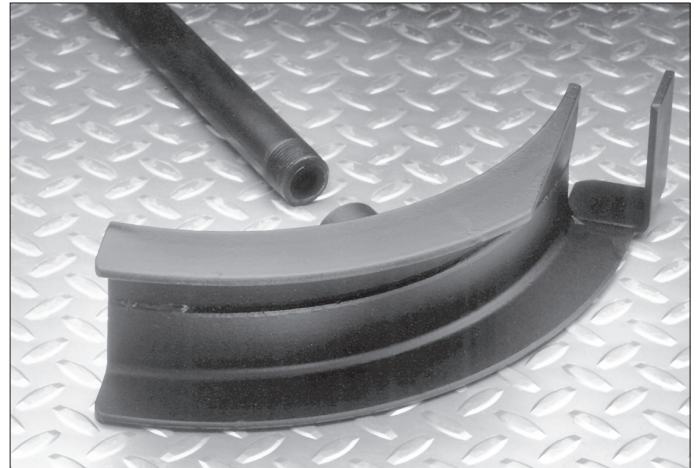

2 1/8" (54mm) Centerline Tool

A replacement for the standard tube bender, it brings the process tubes to the correct centerline for connecting to typical transmitters. This tool makes back-to-back bends easier accomplishing the bends in a much shorter distance than possible with a standard tube bender.

To Order: Centerline-Tool

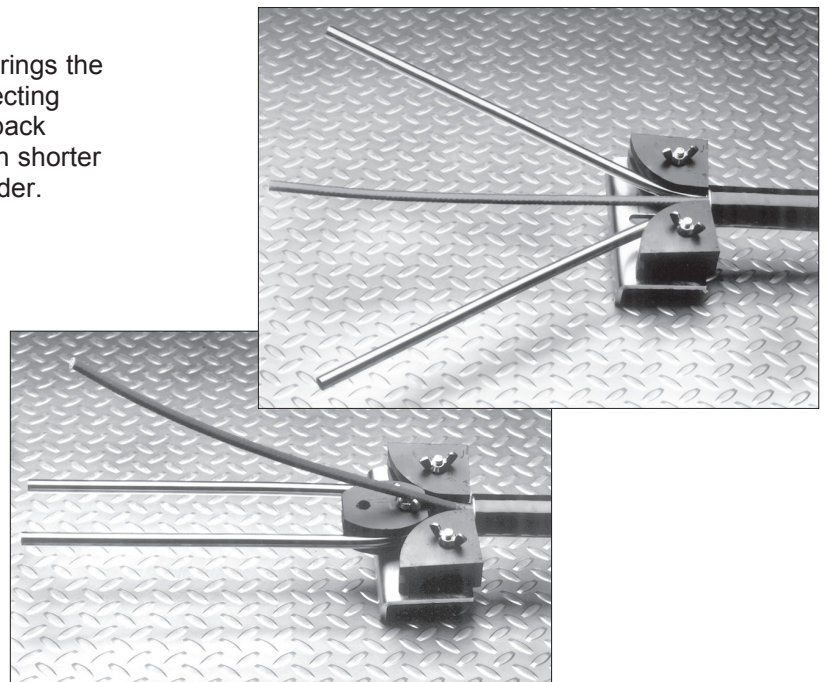
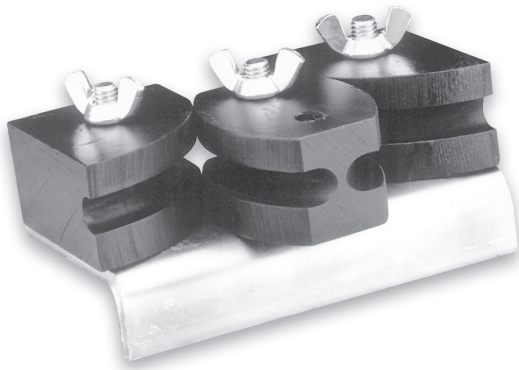

Installation DVD

Helpful information on the installation of TRACEPAK tubing bundles. The DVD deals with general installation procedures and gives a good overview of the products and accessories available to complement and complete the total package.

To Order: Installation-CD

DESIGN REQUEST

The TRACEPAK® DESIGN REQUEST is also available online at www.obcorp.com/DesignRequest.htm



sales.obrien@ametech.com • www.obcorp.com

Required By: _____

From: _____

End User: _____

Date: _____

Notes: _____

SITE CONDITIONS

Outdoor Indoor Low Ambient _____ °F/C High Ambient _____ °F/C Wind 25mph

HEATING CONDITIONS

Desired Maintenance Temperature _____ °F/C

Minimum Maintain _____ °F/C Maximum Maintain _____ °F/C

If an Analyzer Line what is the inlet temperature of gas? _____ °F/C

PROCESS TUBING

Quantity _____ ft/M Are Exact Cut Lengths Required? _____ ft/M

Number of Process Tubes _____

O.D. of #1 Process Tube _____ in/mm Welded or Seamless?

Wall Thickness _____ in/mm Material of Construction _____

O.D. of #2 Process Tube _____ in/mm Welded or Seamless?

Wall Thickness _____ in/mm Material of Construction _____

IF ELECTRIC TRACING

Electrical Voltage _____ VAC Area Classification _____ Division _____

Will Steam be used to blow down this bundle? _____ What Temperature or Pressure _____ °F/C or psig/Barg

IF STEAM TRACING

Steam Pressure _____ psig/Barg Temperature _____ °F/C

Maximum Blow Down Temperature _____ °F/C

O.D. Tracer Tube _____ in/mm Welded or Seamless?

Wall Thickness _____ in/mm Material of Construction _____

ACCESSORIES

- | | | |
|--|---|---|
| <input type="checkbox"/> Heat Shrink Boots | <input type="checkbox"/> Entry Fittings | <input type="checkbox"/> SensorTube™ |
| <input type="checkbox"/> Thermostats | <input type="checkbox"/> Power Kits | <input type="checkbox"/> RTD / PT100 Kits |
| <input type="checkbox"/> Termination Kits | <input type="checkbox"/> Splice Kits | <input type="checkbox"/> Controllers |
| <input type="checkbox"/> Jacket Patch Kits | <input type="checkbox"/> Silicone End Sealant | <input type="checkbox"/> Installation DVD |

OTHER TRACING LIQUIDS - Flow must be turbulent

Flow Rate _____ lbs/hr

Specific Heat _____ Btu/lb°F

Minimum Inlet Temperature (for heating) _____ °F/C

Maximum Inlet Temperature (for cooling) _____ °F/C

Density _____ lb/ft³ Viscosity _____ centipoise

HEAT EXCHANGER APPLICATIONS - Flow must be turbulent

LIQUID OR GAS

Flow Rate _____ lb/hr Temperature at inlet _____ °F/C

Desired Temperature at Outlet _____ °F/C Density _____ lb/ft³

Maximum allowable outlet temp _____ °F/C Viscosity _____ centipoise

Minimum allowable outlet temp _____ °F/C Specific Heat _____ Btu/lb°F

Thermal Conductivity _____ Btu.hr ft²°F

(O'Brien will determine minimum length for heat exchanger applications)

NOTES:

TUBE SPECIFICATIONS



This is a condensed list of tube and tracer options. For a full product offering consult factory.

| Designation | OD | Wall | Material | Construction | Specifications |
|-------------|------|--------|-------------------|--------------|---|
| F1 | 1/8" | 0.035" | 316/316L w/2.5 Mo | Seamless | A213, A269 |
| F2 | 1/4" | 0.035" | 316/316L w/2.5 Mo | Seamless | A213, A269 |
| F3 | 3/8" | 0.035" | 316/316L w/2.5 Mo | Seamless | A269, A269 |
| F4 | 1/2" | 0.035" | 316/316L w/2.5 Mo | Seamless | A213, A269 |
| B2 | 1/4" | 0.049" | 316/316L w/2.5 Mo | Seamless | A213, A269 |
| B3 | 3/8" | 0.049" | 316/316L w/2.5 Mo | Seamless | A213, A269 |
| B4 | 1/2" | 0.049" | 316/316L w/2.5 Mo | Seamless | A213, A269 |
| B6 | 3/4" | 0.049" | 316/316L w/2.5 Mo | Seamless | A213, A269 |
| K4 | 1/2" | 0.065" | 316/316L w/2.5 Mo | Seamless | A213, A269 |
| K8 | 1" | 0.065" | 316/316L w/2.5 Mo | Seamless | A213, A269 |
| A2 | 1/4" | 0.035" | 316/316L SS | Welded | A269 |
| A3 | 3/8" | 0.035" | 316/316L SS | Welded | A269 |
| A4 | 1/2" | 0.035" | 316/316L SS | Welded | A269 |
| E4 | 1/2" | 0.049" | 316/316L SS | Welded | A269 |
| N2 | 1/4" | 0.035" | Alloy 400 | Seamless | B163, B165 |
| N3 | 3/8" | 0.035" | Alloy 400 | Seamless | B163, B165 |
| P4 | 1/2" | 0.049" | Alloy 400 | Seamless | B163, B165 |
| J2 | 1/4" | 0.030" | Copper | Seamless | B68, B75 |
| C3 | 3/8" | 0.032" | Copper | Seamless | B68, B75 |
| D4 | 1/2" | 0.035" | Copper | Seamless | B68, B75 |
| M4 | 1/2" | 0.049" | Copper | Seamless | B68, B75 |
| M6 | 3/4" | 0.049" | Copper | Seamless | B68, B75 |
| G2 | 1/4" | 0.030" | PFA | Extruded | D3307 |
| S2 | 1/4" | 0.040" | PFA | Extruded | D3307 |
| G3 | 3/8" | 0.030" | PFA | Extruded | D3307 |
| H3 | 3/8" | 0.062" | PFA | Extruded | D3307 |
| H4 | 1/2" | 0.062" | PFA | Extruded | D3307 |
| MF6 | 6mm | 1mm | 316/316L | Seamless | A213, A269, DIN 17458 1.4401/1.4404† |
| MF8 | 8mm | 1mm | 316/316L | Seamless | A213, A269, DIN 17458 1.4401/1.4404† |
| MF10 | 10mm | 1mm | 316/316L | Seamless | A213, A269, DIN 17458 1.4401/1.4404† |
| MF12 | 12mm | 1mm | 316/316L | Seamless | A213, A269, DIN 17458 1.4401/1.4404† |
| MB10 | 10mm | 1.5mm | 316/316L | Seamless | A213, A269, DIN 17458 1.4401/1.4404† |
| MB12 | 12mm | 1.5mm | 316/316L | Seamless | A213, A269, DIN 17458 1.4401/1.4404† |
| MD6 | 6mm | 1mm | Copper | Seamless | B68, B75 |
| MD8 | 8mm | 1mm | Copper | Seamless | B68, B75 |
| MD12 | 12mm | 1mm | Copper | Seamless | B68, B75 |
| MG6 | 6mm | 1mm | PFA | Extruded | D3307 |
| MG8 | 8mm | 1mm | PFA | Extruded | D3307 |
| MG10 | 10mm | 1mm | PFA | Extruded | D3307 |
| MG12 | 12mm | 1mm | PFA | Extruded | D3307 |
| MA12 | 12mm | 1mm | 316/316L SS | Welded | A269 |

† Except 3% MAX Mo, 16% MIN Cr

JACKET

- TPU** – Thermoplastic Polyether Urethane Elastomer
- Hydrolytically Stabilized
 - Halogen Free
 - Excellent Abrasion Resistance
 - Excellent UV Resistance

- SV47** – Formulated PVC
- Economical
 - Low Temperature Formulation
 - UV Resistant Additives

INSULATION

- Fibrous Glass
- Water Soluble Chlorides less than 100 ppm.
- Non-hygroscopic

TEMPERATURE LIMITS

| Jacket | Min Installation | Min Service |
|-------------|------------------|-------------|
| TPU | -40°F/-40°C | -67°F/-58°C |
| SV47 | -10°F/-23°C | -30°F/-35°C |

Maximum jacket surface temperature
140°F (60°C) at ambient temperature of
80°F (27°C) with maximum process or
tracer tube temperature.

TPH, TPL and S-LINE

Maximum process tube temperature
400°F (204°C)*

TPE

- Continuous exposure power on.
- High Temperature Tracer**
250°F (120°C)*
 - Low Temperature Tracer**
150°F (65°C)*

- Intermittent exposure power on or off.
- High Temperature Tracer**
482°F (250°C)*
 - Low Temperature Tracer**
185°F (85°C)*

- Maximum tracer temperature
- High Temperature Tracer**
T-rating T3, 392°F (200°C)
except 20 w/ft T2 446°F (230°C)
 - Low Temperature Tracer**
T-rating T6, 185°F (85°C)

*Consult factory for higher temperature limits.

Customer Service

O'Brien's reputation as a customer oriented problem solver has been long recognized.

Our customer-oriented approach offers:

- Responsive, knowledgeable personnel.
- Unparalleled delivery service.
- Dependable, tested results of all product lines.
- On-line order status and shipment tracking.

ISO 9001

Unparalleled quality system to current ISO 9001 standards.

O'Brien's adherence to recognized international standards is your strongest assurance of our quality.

Total Solution

O'Brien products and solutions improve instrument accuracy. Our total engineering package will reduce field installation costs and provide a dependable solution for your needs.

BELGIUM • BRAZIL • CHINA • RUSSIA • SINGAPORE • SOUTH KOREA • USA
www.obcorp.com

Specifications subject to change without notice.

© 2016, by AMETEK, Inc. All rights reserved • QLT-TPBR • 20 SEPT 2017

sales.obrien@ametek.com



ISO 9001